

SECTION 1

SUPPLY / RETURN / VAV BOXES / ACCESSORIES

SUPPLY

TMR – Round.....2
TMS – Lay-In, Square Face3
OMNI – Lay-in, Plaque.....3
250 – Curved Blade.....4
TDC – Louvered Face5
PCS – Perforated.....6
PAS – Perforated.....6
ML – Linear Diffusers.....7
SD – Plenum Diffusers and ML Plenums.....8
VFS – Vari-Flow Diffuser.....9
300RS – Double Deflection 10

RETURN

350-RL – Return..... 11
50F – Eggcrate 12
PAR – Perforated..... 13
PXP – Perforated..... 13
350-RLF – Filter Grille 14

VAV BOXES

ESV-3000 15
Pneumatic Controllers 15
2-Row Water Coils..... 15

ACCESSORIES

TRM Surface Mount Frame 16
Touch-Up Paint 16

TITUS MODEL TMR

Horizontal discharge pattern. 2 Position settings, Steel, White finish.



Stock #	Neck Size	CFM @ NC30	List Price
TMR6	6"	220	\$66.00
TMR8	8"	350	\$70.00
TMR10	10"	545	\$78.00
TMR12	12"	750	\$88.00
TMR14	14"	955	\$100.00
TMR16	16"	1200	\$132.00

Optional Damper		
Stock #	Size	List Price
D1006	6"	\$14.00
D1008	8"	\$16.00
D10010	10"	\$16.00
D10012	12"	\$17.00
AG7514	14"	\$34.00
AG7516	16"	\$40.00

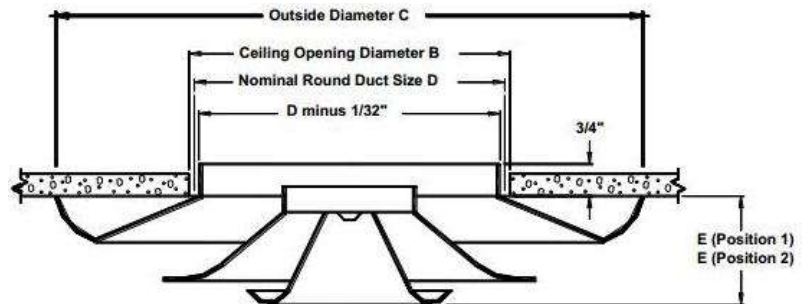
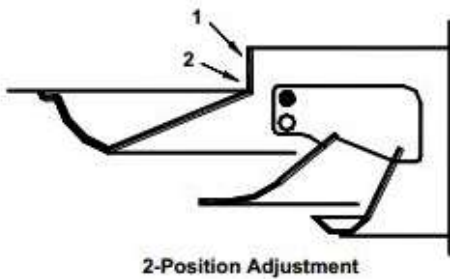

Nominal Round Duct size D	B	C	E (Pos. 1)	E (Pos. 2)
6	6 1/2"	11 1/8"	1 3/4"	1 1/8"
8	8 1/2"	14 3/4"	2 1/8"	1 1/2"
10	10 1/2"	18 1/4"	2 7/8"	2 1/8"
12	12 1/2"	22"	3 1/8"	2 3/8"
14	14 1/2"	26"	3 3/8"	2 5/8"
16	16 1/2"	29"	4"	3 1/4"
18	18 1/2"	32 1/2"	4 3/4"	3 7/8"
20	20 1/2"	36"	5 7/8"	4 7/8"
24	24 1/2"	43 1/4"	7 3/4"	6 5/8"

TITUS MODEL TMS



Lay-In. Steel. White finish. Good for VAV application.

24 X 24 Module			
Stock #	Neck Size	CFM @ NC 30	List Price
TMS36	6"	250	\$50.00
TMS38	8"	400	\$50.00
TMS310	10"	550	\$50.00
TMS312	12"	750	\$50.00
TMS314	14"	950	\$50.00
TMS315	15"	1100	\$50.00

12 X 12 Module			
Stock #	Neck Size	CFM @ NC 30	List Price
TMS361212	6"	200	\$33.00
TMS381212	8"	350	\$33.00

TITUS MODEL OMNI



Lay-in. Steel. White finish. Good for VAV application.

24 x 24 Module			
Stock #	Neck Size	CFM @ NC 30	List Price
OMNI36	6"	250	\$60.00
OMNI38	8"	360	\$60.00
OMNI310	10"	570	\$60.00
OMNI312	12"	770	\$60.00
OMNI314	14"	980	\$60.00

12 x 12 Module			
Stock #	Neck Size	CFM @ NC 30	List Price
OMNI361212	6"	200	\$42.00
OMNI381212	8"	360	\$42.00



Optional Damper			
Stock #	Size	List Price	
D1006	6"	\$14.00	
D1008	8"	\$16.00	
D10010	10"	\$16.00	
D10012	12"	\$17.00	
D10014	14"	\$28.00	
AG7515	15"	\$38.00	



Optional Surface Mount Frame		
Stock #	Size	List Price
PF1212 FRAME	12" X 12"	\$20.00
PF2424 FRAME	24" X 24"	\$26.00

TITUS MODEL 250 Frame 1



Steel ceiling or sidewall diffuser. Adjustable curved blade with mounted AG-15 damper. Surface mount. White finish.

4-Way Pattern			
Stock #	Neck Size	CFM @ NC 30	List Price
250S46	6" X 6"	135	\$41.00
250S48	8" X 8"	210	\$44.00
250S410	10" X 10"	350	\$53.00
250S412	12" X 12"	470	\$60.00
250S414	14" X 14"	625	\$74.00
250S416	16" X 16"	750	\$85.00
250S418	18" X 18"	1000	\$110.00
250S420	20" X 20"	1200	\$120.00

Border Type 1 (Surface Mount)*

Dimensions are in inches.

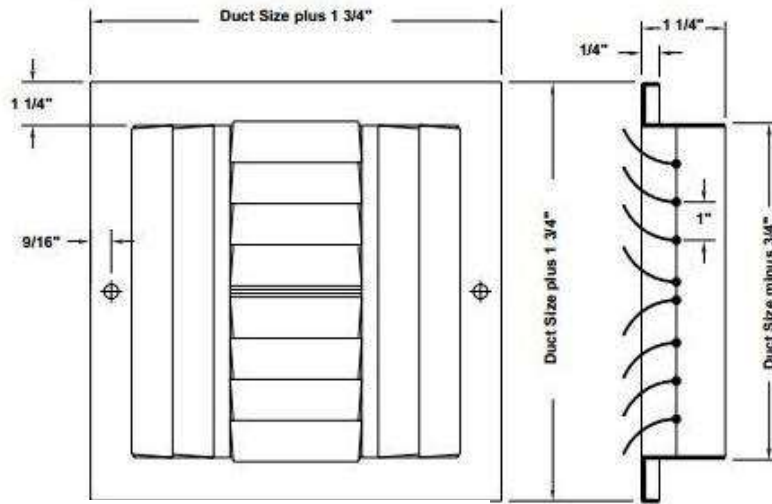

Model AG-15 Opposed Blade Damper

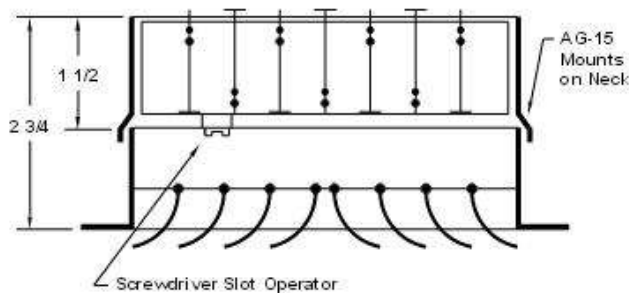

Note: Total depth is 3" with damper open

TITUS MODEL TDC Frame 3



Lay-in. Louvered face. 24 X 24 panel. Round neck. 4-Way

Stock #	Neck Size	CFM @ NC30	List Price
4TDC36R6	6" X 6" / 6"	170	\$60.00
4TDC39R8	9" X 9" / 8"	300	\$66.00
4TDC312R10	12" X 12" / 10"	480	\$80.00
4TDC312R12	12" X 12" / 12"	600	\$80.00
4TDC315R14	15" X 15" / 14"	770	\$104.00
4TDC318R16	18" X 18" / 16"	980	\$128.00

Border Type 3 (Lay-In)

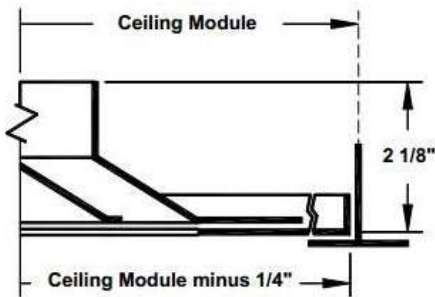

D100

Optional Damper		
Stock #	Size	List Price
D1006	6"	\$14.00
D1008	8"	\$16.00
D10010	10"	\$16.00
D10012	12"	\$17.00
D10014	14"	\$28.00
AG7515	15"	\$38.00

TITUS MODEL TDC Frame 6



Surface mount. Louvered face. Square neck. 4-way throw

Stock #	Neck Size	CFM @ NC30	List Price
4TDC66	6" X 6"	195	\$30.00
4TDC69	9" X 9"	394	\$37.00
4TDC612	12" X 12"	650	\$50.00
4TDC615	15" X 15"	950	\$66.00
4TDC618	18" X 18"	1300	\$83.00
4TDC621	21" X 21"	1710	\$116.00

Border Type 6 (Beveled Drop Face)

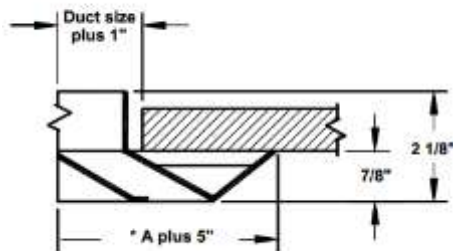

AG-95

Optional Damper		
Stock #	Size	List Price
AG956	6" X 6"	\$11.00
AG959	9" X 9"	\$15.00
AG9512	12" X 12"	\$20.00
AG9515	15" X 15"	\$36.00
AG9518	18" X 18"	\$48.00
AG9521	21" X 21"	\$60.00

TITUS MODEL PCS Frame 3



Lay-in. Perforated face. 24 x 24 module. 4-way throw
Curved blade with round neck. White finish.

Round Neck			
Stock #	Neck Size	CFM @ NC30	List Price
APC3FW 06	6"	110	\$52.00
APC3FW 08	8"	190	\$52.00
APC3FW 10	10"	270	\$52.00
APC3FW 12	12"	380	\$52.00
APC3FW 14	14"	460	\$52.00
APC3FW 16	16"	560	\$60.00

Square Neck (Tucson stock)			
Stock #	Neck Size	CFM @ NC30	List Price
APC3FW 0606	6" X 6"	140	\$60.00
APC3FW 0808	8" X 8"	222	\$60.00
APC3FW 1010	10" X 10"	324	\$60.00
APC3FW 1212	12" X 12"	433	\$60.00
APC3FW 1414	14" X 14"	580	\$60.00
APC3FW 1616	16" X 16"	711	\$64.00
APC3FW1818	18" X 18"	820	\$64.00

TITUS MODEL PAS Frame 3

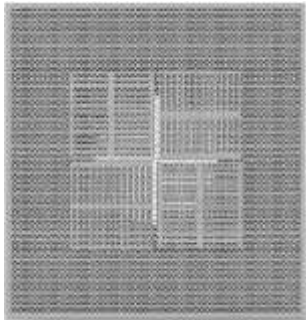

Lay-in. Perforated face, round neck. 24 X 24 module. White

24 X 24 Module			
Stock #	Neck Size	CFM @ NC30	List Price
PAS3F6	6"	180	\$44.00
PAS3F8	8"	265	\$44.00
PAS3F10	10"	350	\$44.00
PAS3F12	12"	470	\$44.00
PAS3F14	14"	575	\$44.00
PAS3F16	16"	680	\$62.00

Optional Damper - Round		
Stock #	Size	List Price
D1006	6"	\$14.00
D1008	8"	\$16.00
D10010	10"	\$16.00
D10012	12"	\$17.00
D10014	14"	\$28.00
AG7516	16"	\$40.00

Optional Damper - Square		
Stock #	Size	List Price
AG156	6" X 6"	\$14.00
AG158	8" X 8"	\$15.00
AG1510	10" X 10"	\$17.00
AG1512	12" X 12"	\$19.00
AG1514	14" X 14"	\$24.00
AG1516	16" X 16"	\$30.00

Optional Surface Mount Frame		
Stock #	Size	List Price
PF2424 FRAME	24" X 24"	\$26.00

TITUS MODEL ML-39 for surface mount



Linear 2 slot diffusers w/ 1" slots. Endcaps included.

Frame 1A with screw-holes		
Stock #	Size	List Price
ML394	4' long	\$100.00

Frame 2A concealed mount – for surface mount		
Stock #	Size	List Price
ML3942A	4' long	\$120.00

End cap	
Stock #	List Price
MLEB3902	\$10.00

Oval Plenum Damper with Remote Controller and Cable	
Stock #	List Price
800AWO-T-08	\$98.00
800AWO-T-10	\$102.00
800AWO-T-12	\$114.00

- Border Type 2A with
 - Flanged Border
 - Concealed Mounting

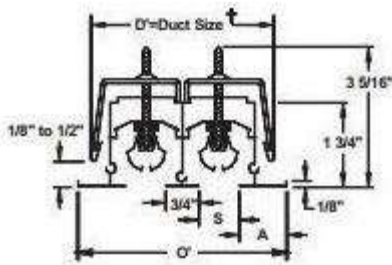

Type	A	O'	D'
1A	1-1/8"	D' + 3/4"	4-1/8"
2A	1-1/8"	D' + 3/4"	4-1/4"

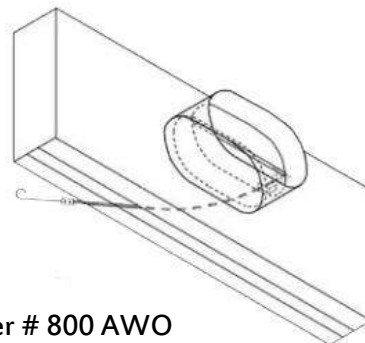

Oval Damper # 800 AWO

TITUS MODEL MPI-39

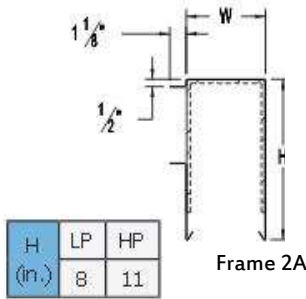

2 Slot insulated plenum for Titus ML linear, 8" high

Frame 1A – Screw Mount			
Stock #	Size	Inlet	List Price
MPI394-8	4' long	8" oval	\$58.00
MPI394	4' long	10" oval	\$58.00
MPI394-12	4' long	12" oval	\$58.00

Frame 2A – Concealed Mount			
Stock #	Size	Inlet	List Price
MPI3942A-8	4' long	8" oval	\$58.00
MPI3942A	4' long	10" oval	\$58.00
MPI3942A-12	4' long	12" oval	\$58.00

PLENUM DIFFUSER TITUS TBDI-80 for lay-in

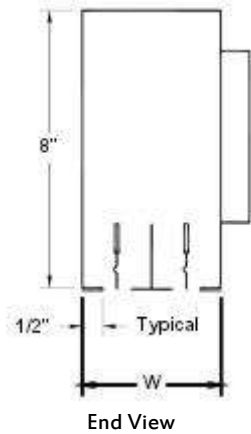

2-Slot insulated plenum diffusers for T-Bar w/1" slots and with center and outside "T". 11 5/8" high

Stock #	Size	Inlet	List Price
SD222T	2' long	8" round	\$120.00
SD422T	4' long	8" round	\$140.00
SD422T10	4' long	10" oval	\$140.00

THERMAL PRODUCTS VARI-FLOW CEILING DIFFUSER



24 X 24 panel. Variable volume cooling –
Constant volume heating.

Round Neck			
Stock #	Neck Size	CFM @ NC30	List Price
VFS8H	8"	250	\$500.00
VFS10H	10"	730	\$500.00
VFS12H	12"	630	\$500.00

Optional Surface Mount Frame		
Stock #	Size	List Price
PF2424 FRAME	24" X 24"	\$26.00

The VARI-FLOW provides individual temperature control for cooling or heating at each diffuser, adjustable from 70 to 78°F. The unit is in cooling mode when the supply duct air temperature is below 70 degree F. The unit is in the heat mode when duct temperature greater than 78°F and provides a constant air volume. The VFS-24 diffuser is totally self-contained and self-powered by a thermal element with automatic change over for heating and cooling.

INSTALLATION INSTRUCTIONS
VFS24 SERIES VARI-FLOW™ DIFFUSER

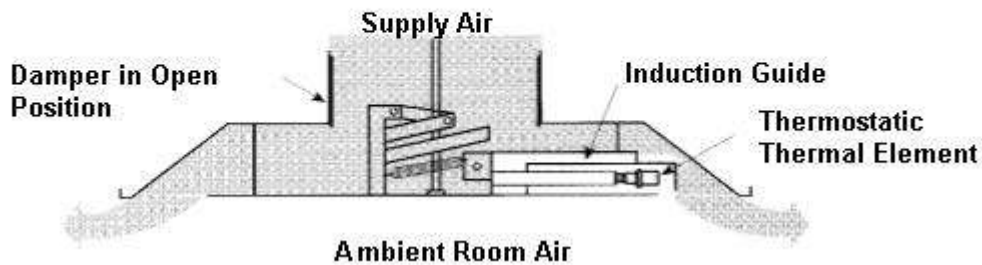

TITUS MODEL 300RS

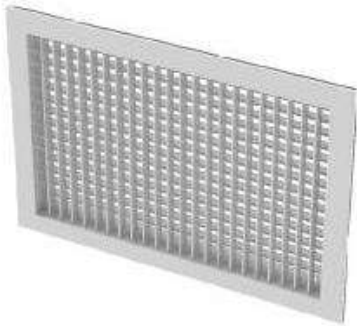

Steel sidewall supply registers. Double deflection. Adjustable. with AG-15 opposed blade damper. Front blades run short dimension. White finish.

Double Deflection Models 300RL/RS - Border Type 1

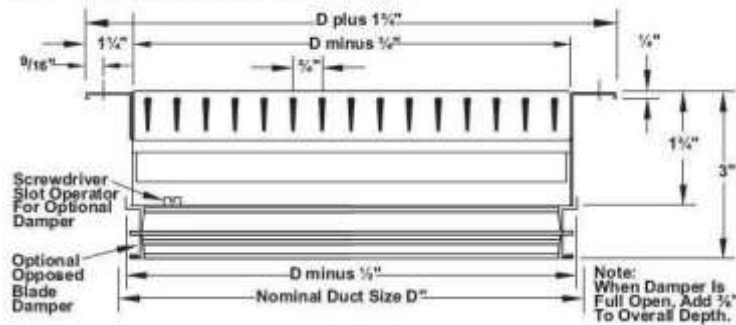

Stock #	Neck Size	List Price
300RS6	6" X 6"	\$36.00
300RS86	8" X 6"	\$37.00
300RS106	10" X 6"	\$40.00
300RS126	12" X 6"	\$42.00
300RS146	14" X 6"	\$46.00
300RS166	16" X 6"	\$50.00
300RS186	18" X 6"	\$55.00
300RS206	20" X 6"	\$59.00
300RS246	24" X 6"	\$65.00
300RS8	8" X 8"	\$36.00
300RS108	10" X 8"	\$41.00
300RS128	12" X 8"	\$46.00
300RS148	14" X 8"	\$50.00
300RS168	16" X 8"	\$55.00
300RS188	18" X 8"	\$60.00
300RS208	20" X 8"	\$63.00
300RS248	24" X 8"	\$72.00
300RS10	10" X 10"	\$45.00
300RS1210	12" X 10"	\$50.00
300RS1410	14" X 10"	\$55.00
300RS1610	16" X 10"	\$60.00
300RS1810	18" X 10"	\$66.00
300RS2010	20" X 10"	\$70.00
300RS2410	24" X 10"	\$100.00
300RS1212	12" X 12"	\$54.00
300RS2412	24" X 12"	\$87.00

TITUS MODEL 350RL



Return Grille. Fixed blade. Steel construction. Blades long dimension. 1-1/4" border. 35° fixed blades on 3/4" centers. White finish.

Surface Mount		
Stock #	Neck Size	List Price
350RL6	6" X 6"	\$11.00
350RL86	8" X 6"	\$14.00
350RL106	10" X 6"	\$18.00
350RL126	12" X 6"	\$22.00
350RL146	14" X 6"	\$26.00
350RL166	16" X 6"	\$20.00
350RL186	18" X 6"	\$24.00
350RL206	20" X 6"	\$24.00
350RL246	24" X 6"	\$30.00
350RL8	8" X 8"	\$18.00
350RL108	10" X 8"	\$18.00
350RL128	12" X 8"	\$22.00
350RL148	14" X 8"	\$26.00
350RL168	16" X 8"	\$20.00
350RL188	18" X 8"	\$25.00
350RL208	20" X 8"	\$24.00
350RL248	24" X 8"	\$28.00

T-Bar Ceiling		
Stock #	Neck Size	List Price
350RLT2210	22" X 10"	\$30.00
350RLT2222	22" X 22"	\$60.00
350RLT4622	46" X 22"	\$112.00

Optional Damper		
Stock #	Size	List Price
AG152210	22" X 10"	\$27.00
AG1522	22" X 22"	\$55.00

Surface Mount		
Stock #	Neck Size	List Price
350RL10	10" X 10"	\$20.00
350RL1210	12" X 10"	\$22.00
350RL1410	14" X 10"	\$26.00
350RL1610	16" X 10"	\$26.00
350RL1810	18" X 10"	\$30.00
350RL2010	20" X 10"	\$28.00
350RL2410	24" X 10"	\$32.00
350RL12	12" X 12"	\$22.00
350RL1412	14" X 12"	\$26.00
350RL1612	16" X 12"	\$28.00
350RL1812	18" X 12"	\$30.00
350RL2012	20" X 12"	\$32.00
350RL2412	24" X 12"	\$34.00
350RL14	14" X 14"	\$28.00
350RL16	16" X 16"	\$34.00
350RL18	18" X 18"	\$42.00
350RL20	20" X 20"	\$50.00
350RL24	24" X 24"	\$70.00
350RL4824	48" X 24"	\$134.00

Optional Damper - Square		
Stock #	Size	List Price
AG156	6" X 6"	\$14.00
AG158	8" X 8"	\$15.00
AG1510	10" X 10"	\$17.00
AG1512	12" X 12"	\$19.00
AG1514	14" X 14"	\$24.00
AG1516	16" X 16"	\$30.00
AG1518	18" X 18"	\$36.00
AG1520	20" X 20"	\$50.00
AG1524	24" X 24"	\$60.00

TITUS MODEL 50-F

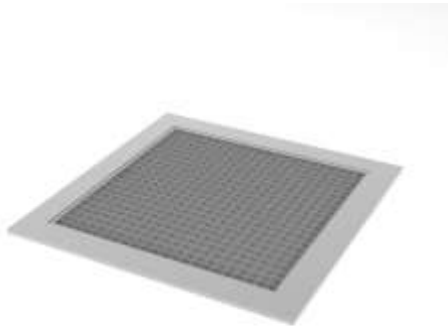

Eggcrate return grille. 1/2" X 1/2" X 1/2" aluminum construction. White finish.

T-Bar Ceiling		
Stock #	Neck Size	List Price
50F2210	22" X 10"	\$30.00
50F22	22" X 22"	\$51.00
50F4622	46" X 22"	\$111.00

Optional Damper		
Stock #	Size	List Price
AG152210	22" X 10"	\$27.00
AG1522	22" X 22"	\$55.00

Surface Mount		
Stock #	Neck Size	List Price
50F6	6" X 6"	\$14.00
50F8	8" X 8"	\$17.00
50F10	10" X 10"	\$20.00
50F12	12" X 12"	\$23.00
50F14	14" X 14"	\$34.00
50F16	16" X 16"	\$33.00
50F18	18" X 18"	\$40.00
50F20	20" X 20"	\$47.00
50F24	24" X 24"	\$60.00

Optional Damper		
Stock #	Size	List Price
AG156	6" X 6"	\$14.00
AG158	8" X 8"	\$15.00
AG1510	10" X 10"	\$17.00
AG1512	12" X 12"	\$19.00
AG1514	14" X 14"	\$24.00
AG1516	16" X 16"	\$30.00
AG1518	18" X 18"	\$36.00
AG1520	20" X 20"	\$50.00
AG1524	24" X 24"	\$60.00

TITUS MODEL PAR Frame 3

Lay-in return grille. Perforated face. White finish.



Round Neck / 24 X 24 Module		
Stock #	Neck Size	List Price
PAR3F8	8"	\$44.00
PAR3F10	10"	\$44.00
PAR3F12	12"	\$44.00
PAR3F14	14"	\$44.00
PAR3F16	16"	\$60.00

Border Type 3 (Lay-In when D=Module size -2)

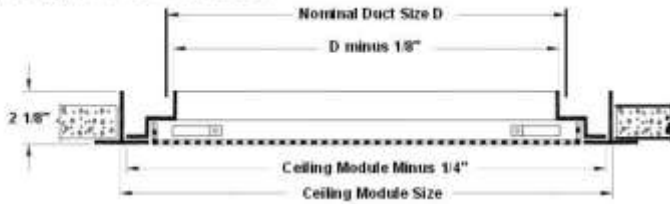

Square Neck		
Stock #	Neck Size	List Price
PAR3F1022	10" X 22"	\$44.00
PAR3F22	22" X 22"	\$44.00
PAR3F2246	22" X 46"	\$72.00

Optional Surface Mount Frame		
Stock #	Neck Size	List Price
PF24212FRAME	24" X 12"	\$22.00
PF2424FRAME	24" X 24"	\$26.00

TITUS MODEL PXP Frame 3

Perforated panel return. No frame. White finish.

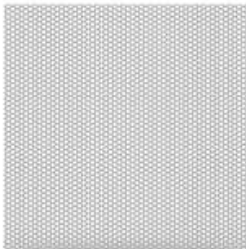

T-Bar Ceiling		
Stock #	Neck Size	List Price
PXP2424	24" X 24"	\$22.00

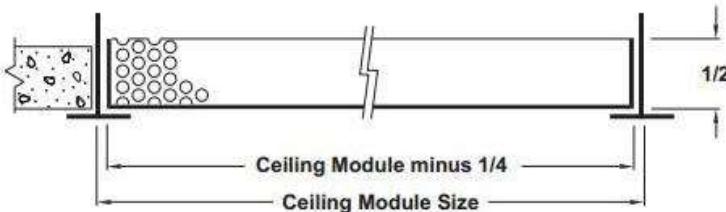

TITUS MODEL 350RLF



T-Bar Ceiling (For 1" Filter)			
Stock #	Filter Size	Panel Size	List Price
350RLF1T20	20" X 20" X 1"	24" X 24"	\$120.00
350RLF1T4420	44" X 20" X 1"	48" X 24"	\$220.00

T-Bar Ceiling (For 2" Filter)			
Stock #	Filter Size	Panel Size	List Price
350RLF2T20	20" X 20" X 2"	24" X 24"	\$136.00

Surface Mount (For 1" Filter)		
Stock #	Filter Size	List Price
350RLF12014	20" X 14"	\$72.00
350RLF12016	20" X 16"	\$72.00
350RLF1T20	20" X 20"	\$120.00
350RLF124	24" X 24"	\$118.00
350RLF12514	25" X 14"	\$85.00
350RLF12516	25" X 16"	\$105.00
350RLF12520	25" X 20"	\$115.00
350RLF13020	30" X 20"	\$122.00
350RLF14020	40" X 20"	\$194.00

350RLF1/350RLF2 - Border Type 1(Surface Mount) & Border Type 3 (Lay-in T-Bar)

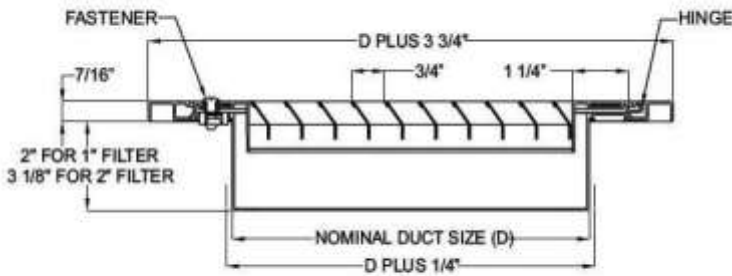

Available sizes (D" x D") are 10 x 8 inches through 48 x 36 inches in 1-inch increments. Odd sizes are available at additional cost.

Surface Mount (For 2" Filter)		
Stock #	Filter Size	List Price
350RLF2T20	20" X 20" X 2"	\$136.00

►► FOR FILTER PRICING – SEE PAGES 46 - 47

TITUS MODEL DESV-3000



Variable volume. Pressure independent.
 1/2" ECO-SHIELD liner (Non-fiberglass), with control enclosure,
 toggle disconnect, and mounted 120-24 volt control transformer.

Bare Boxes for Controls Mounted by Others				
Stock #	Size	CFM Range	Outlet	List Price
ESV-NOCONTROL06	6"	80 - 500	12" X 8"	\$250.00
ESV-NOCONTROL08	8"	145 - 900	12" X 10"	\$288.00
ESV-NOCONTROL10	10"	230 - 1400	14" X 12.5"	\$300.00
ESV-NOCONTROL12	12"	325 - 2000	16" X 15"	\$320.00
ESV-NOCONTROL14	14"	450 - 3000	20" X 17.5"	\$374.00
ESV-NOCONTROL16	16"	580 - 4000	24" X 18"	\$394.00

TITUS PNEUMATIC CONTROLLER



Pneumatic controls direct acting/normally open. Can be changed
 in the field to RA/NC.

Stock #	List Price
II Controller	\$190.00

TITUS 2-ROW WATER COIL



Copper tubing, aluminum fins. Housed in galvanized casing. Coil
 mounts at discharge outlet. Slip and drive duct connection. Coil
 ships loose.

Stock #	Size	Dimensions	Fits	List Price
COIL6	6"	12" X 8"	ESV6	\$140.00
COIL8	8"	12" X 10"	ESV8	\$170.00
COIL10	10"	14" X 12.5"	ESV10	\$220.00
COIL12	12"	16" X 15"	ESV12	\$270.00
COIL14	14"	20" X 17.5"	ESV14	\$330.00
COIL16	16"	24" X 18"	ESV16	\$420.00

TITUS MODEL TRM



Surface mount frame.

Optional Surface Mount Frame		
Stock #	Size	List Price
PF1212FRAME	12" X 12"	\$20.00
PF2412FRAME	24" X 12"	\$22.00
PF2424FRAME	24" X 24"	\$26.00

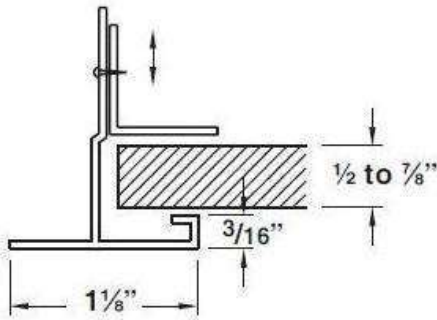

Ceiling Opening View

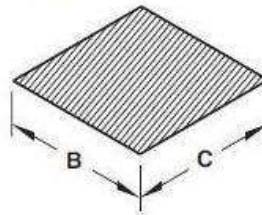

Ceiling Module	Recommended Ceiling Opening	
	B	C
12" X 12"	12-1/2"	12-1/2"
24" X 12"	24-1/2"	12-1/2"
24" X 24"	24-1/2"	24-1/2"

*Check actual dimensions of ceiling opening before installation.

TOUCH UP PAINT



Aerosol can.

Stock #	Color	List Price
PAINT26	White	\$14.00
PAINTBLK	Black	\$14.00